

**LC211/2240**  
**KEDACOM**

**快速安装指南**  
Quick Start Guide



## 前言

感谢您购买我司产品，如对本公司产品有疑问或需要，请随时和我们联系。我们尽最大努力来保证本手册信息的正确性，如因升级等原因发生信息修改，恕不另行通知。

获取最新文档请联系产品供应商。

## 安全说明

此内容（手册）的目的是确保用户正确使用本产品，以避免危险或财产损失。在使用产品之前，请认真阅读此手册并妥善保存以备日后参考。如果用户因没有按照以下安全说明，致使设备不能正常使用或损坏等情况，责任由用户承担。

- 请使用满足安全电压要求的电源。
- 如果设备工作不正常，请联系厂家或最近的服务中心。不要以任何方式随意拆卸或修改设备。
- 请防止此产品从高处摔落或受强烈敲击。
- 清洁镜头时，须使用吹气球或专业镜头布除去镜头上的污垢。清洁透明球罩时，须使用足够柔软、干燥的布擦拭，切勿使用含酒精、苯等清洁剂洗涤。
- 避免将摄像机对准强光（如灯光照明、太阳光等处）聚焦，否则容易引起过亮或漏光现象（这并非摄像机故障）也将影响摄像机寿命。
- 避免将产品暴露在非用户手册所示的工作环境下使用。

工作环境	
工作电源	DC12V
温度	-30°C ~ 60°C
湿度	10%~95% (无凝结)
海拔高度	-60m~3000m
大气压	86kPa~106kPa

- 使用时不可让水或任何液体流入摄像机。
- 当运送摄像机时，请重新以出厂时的包装进行包装，或用同等品质的材质包装。
- 需要替换部件时，请事先与经销商联系，更换指定型号的部件，或与原部件具有相同特性的部件。擅自使用其它部件进行替换，后果自负。
- 本产品非密封防水设备，不能单独工作于室外露天环境。

【说明】更多信息见附带光盘中的《高清网络摄像机用户手册》。

## 吸顶安装说明

### 第一步：打开外罩

拧松外罩内六角螺钉，按图示方向旋转外罩(约1cm)并取下。

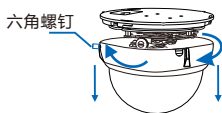

### 第二步：线缆排布

#### 顶部出线

在墙壁或天花板上预留出线孔，将线缆插在设备接口上，并穿过出线孔。

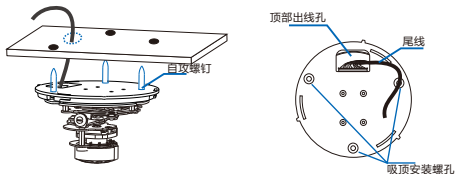

#### 侧方出线

将线缆穿过侧面出线孔，插进设备接口。

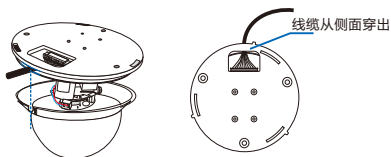

### 第三步：线缆连接

按照右图所示将摄像机连接到PC或网络交换机，连接电源给设备上电。



【说明】本产品不支持音频和告警功能。

#### 第四步：登录设备

1 设备出厂时IP地址为0.0.0.0，第一次使用时请与PC接入同一交换机，使用光盘中附带的IPCSearch分配IP地址。若IPC设备所接入的网络有DHCP服务，DHCP服务器将自动给IPC分配IP地址。

2 运行IPCSearch，搜索并选中需要配置的设备，点击 **修改网络参数** 按钮。静态分配IP地址时，请选择自定义地址，填写以太网参数。



3 完成IP配置后，可直接在IPCSearch中点击 **登录设备** 登录web客户端。如果已配置过IP，可以直接在E地址栏中输入设备的IP地址，连接web客户端。

【说明】首次运行web客户端时，请先下载并安装视频控件。

## 视频控件不存在或需要升级

请下载控件并关闭本页面，安装后  
重新登录！

下载控件

如果下载控件不成功，请进行如下操作：

- 1) 点击IE工具栏Internet选项-安全页签。
- 2) 点击页签上的可信站点-站点按钮，输入该IPC设备地址，并添加。

**【注意】**在添加地址时，请去掉“对该区域中的所有站点要求服务器验证”选项。



如果使用Windows 7或Vista操作系统时，请确认UAC服务已经关闭。

- 1) 打开“开始>运行>msconfig>工具”，选择“更改UAC设置”，点击“启动”按钮。
- 2) 将滑块拖在最底端，点击“确定”后重新启动PC即可。

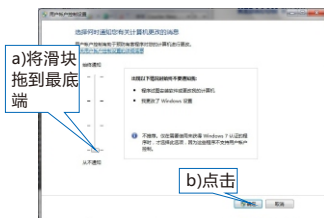
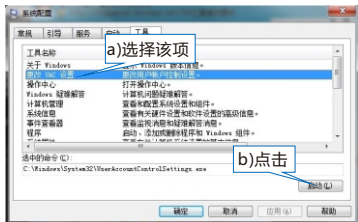

4 设置完成后，请在IE地址栏中重新输入设备的IP地址，并按提示安装控件，登录IPCctrl web客户端。在登录界面输入默认管理员用户名与密码，均为admin，操作员用户名和密码，均为guest。



## 第五步：图像浏览和镜头调整

1 进入客户端后，可以直接浏览图像，界面如图。

【说明】更多客户端说明参见客户端帮助文档。



2 调整设备方向和镜头角度(可调整范围如图所示),直到IPCCtrl中的浏览画面达到预定要求。

【说明】调整镜头角度不宜用力过猛以免损伤设备部件。

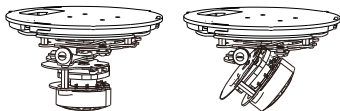

## 第六步：固定设备

1 确定好位置后用三颗自攻螺钉将设备的底座固定在墙壁或天花板上，打孔尺寸详见附录。

### 2 顶部出线

对准外罩出线口(黑色挡片)和底座的出线孔，将外罩装配到底座上，按图示方向旋转外罩，拧紧内六角螺钉固定外罩，撕去防尘纸。

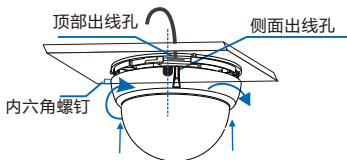

### 3 侧方出线

取下外罩出线孔挡片，将外罩装配到底座上，线缆从出线孔穿出，然后逆时针旋转外罩，直到无法拧动(约1cm)，拧紧内六角螺钉，固定外罩。



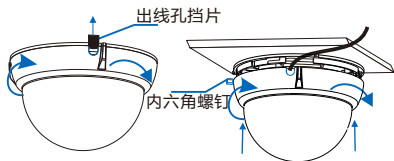

## 支架安装说明

如因环境条件不能采用吸顶安装方式，也可采用吊顶支架或壁装支架进行安装。不推荐在无支架的情况下采用壁装安装方式。

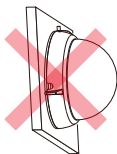

**第一步：安装支架转接件**

将支架转接件用螺钉安装在设备顶部，如图所示。

**第二步：固定支架和转接件**

将支架转接件和支架用螺钉锁紧固定。

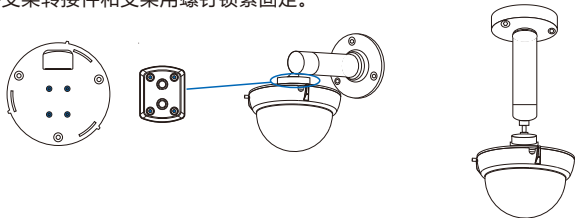

## 附录：可选配件

以下配件不包含在标准产品包中，如有需要请联系经销商。

- 1 吊装支架
- 2 壁装支架
- 3 支架转接件

## 附录：底座尺寸

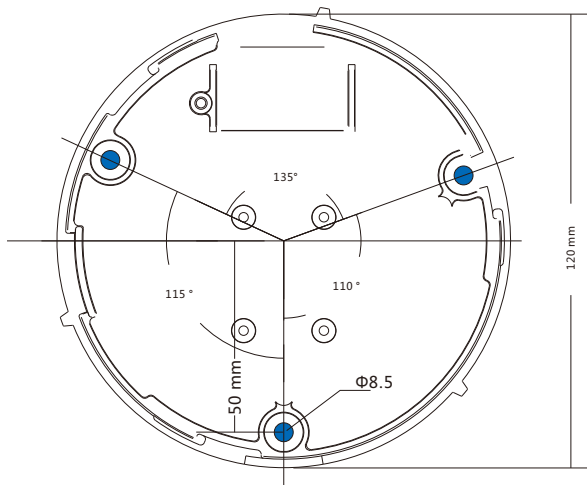

比例尺：1:2

## 保修说明

本保修卡适用于您购买的本公司系列产品。

- 1.终身保质，免费保修期一年，如合同中有另行约定则以合同为准。
- 2.凡保修期内，由于本产品自身引起的故障，请与公司售后服务部联系。
- 3.保修时我们将使用您的保修卡信息，请认真填写。
- 4.以下情况，属于有偿保修范围：
  - 人为原因造成的设备故障
  - 因使用环境不符合本产品要求造成的故障
  - 因不可抗力造成的产品损坏
  - 无保修卡
  - 已过保修期

## 用户信息

用户名称：

详细地址：

传真：

电话：

邮箱：

邮编：

产品名称：

产品型号：

购买日期：

## Trademarks

Kedacom™, TrueSens™ and **KEDACOM**™ are registered trademarks of Suzhou Keda Technology Co., Ltd. in China and various other countries. All other trademarks mentioned in this document are the property of their respective holders.

### **Suzhou Keda Technology Co., Ltd.**

131 Jinshan Road

New District, Suzhou, 215011

People's Republic of China

<http://www.kedacom.com/en>

Tel: +86-512-68418188

Fax: +86-512-68412699

### **© 2014 Suzhou Keda Technology Co., Ltd. All rights reserved.**

Without the prior written permission of Suzhou Keda Technology Co., Ltd., any reproduction, translation or retransmission of all or any part of this document for any purpose in either.

### **Notice**

The information in this document is subject to change without notice. Every effort has been made in the preparation of this document to ensure accuracy of the contents, but all statements, information, and recommendations in this document do not constitute a warranty of any kind, express or implied. Suzhou Keda Technology Co., Ltd. is not responsible for printing or clerical errors electronic or mechanical form is not allowed.

## Preface

Thank you for purchasing our product. If there are any questions, or requests, please do not hesitate to contact us.

Every effort has been made to ensure the accuracy and validity of this Guide. Any update of this Guide is subject to change without notice. For the latest document, please contact the dealer.

## Safety Instruction

These instructions are intended to ensure that the user can use the product correctly to avoid danger or property loss. Please read this Guide carefully before using the product, and keep it properly for future reference. If the product cannot work normally or is damaged because the user does not follow the safety instructions, we shall not assume any responsibility.

- Please adopt power supply in the safety voltage range.
- If the product does not work properly, please contact your dealer or the nearest service center. Never attempt to disassemble or repair the product yourself in any way.
- Do not drop the camera or subject it to physical shock.
- When cleaning the lens, please use a rubber dust blower or lens cleaning cloth to remove the dirt. When cleaning transparent housing, please use soft and dry cleaning cloth to wipe it gently. Never apply any cleanser with ethanol or benzene in it
- Do not focus the camera lens on strong light such as the sun or incandescent lamp. The strong light can cause overexposure or light leak (not camera malfunction), which may shorten camera lifetime.
- Do not expose the camera in the environment not defined in the Guide.

Operating Environment	
Working Voltage	DC12V $\pm$ 10%
Temperature	-30°C~60°C
Humidity	10%~95% (non-condensing)
Altitude	-60m~3000m
Atmospheric Pressure	86kPa~106kPa

- Keep the camera away from water or any liquid.
- While shipping the camera, pack it in the factory packing or use materials with equivalent quality.
- When it is necessary to replace a part, please contact your dealer in advance and replace the part with specified model or part of the same features. We shall not assume any responsibility for problems caused by unauthorized replacement.
- The camera is not water-proof, so it cannot work outdoor alone.

[Note]: For more information, please refer to the *User Manual for HD IP Camera* in the attached CD.

## Ceiling Mount

### Step 1 Take Down the Housing

Unscrew the hexagon screws in the housing and rotate the housing (about 1 cm) as the picture shows to take it down.

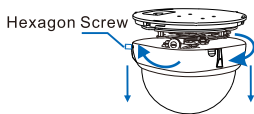

Picture 1

### Step 2 Route Cables

Top cabling

Punch wiring holes on the wall or ceiling, insert the cable into the interface on the camera and route it through the hole.

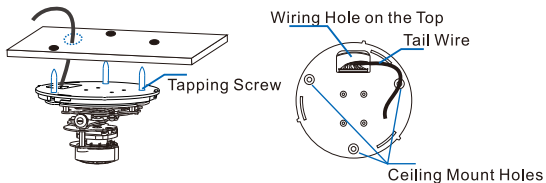

Picture 2

Slide cabling

Route the wire from side hole and insert it into the camera interface.

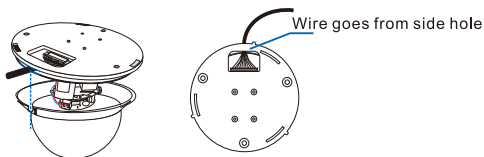

Picture 3

### Step 3 Cable Connection

Connect camera to PC or switch as the picture shows, and power it on.

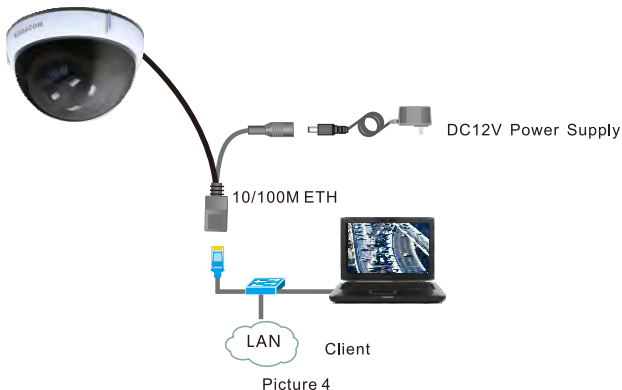

Picture 4

[Note]: This model does not have audio and alarm functions.

#### Step 4 Login Client

Connect camera to PC or switch as the picture shows, and power it on.

1 The factory default IP of camera is 0.0.0.0. Please set the camera and the PC in the same LAN and use IPCSearch to configure IP. If the network provides DHCP service, DHCP server will configure IP for the camera automatically.

2 Run IPCSearch, select the target camera, and click **Modify Params**. When configure a static IP for the camera, please check "Custom device address (Close DHCP)" and fill the Ethernet parameter.

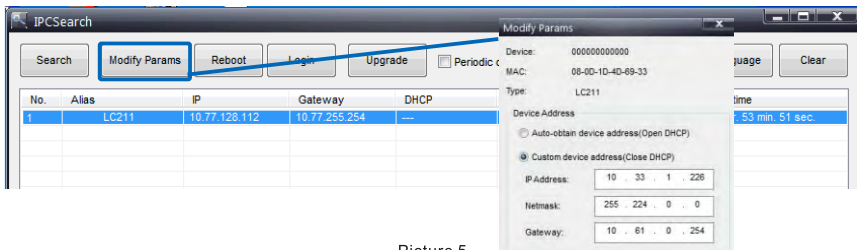

Picture 5

3 After IP configuration, user can click Login to login web client. If IP configuration has been finished, user can input camera IP address in IE to go to web client.

[Note]: When run web client first time, please download and install video ActiveX control.

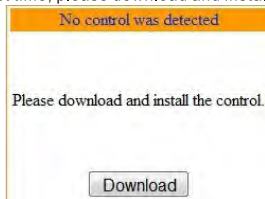

Picture 6

If user fails to download the ActiveX control, operate as follows:

- 1) Click "Internet Options>Security".
- 2) Click "Trusted Sites>Sites", input the IP address of this camera and add.

[Note]: When add an address, uncheck "Require server verification (https:) for all sites in this zone".



Picture 7

If operate under Windows 7 or Vista system, make sure that the UAC service has been disabled.

- 1) Run "Start>Operate>msconfig>Tool", select "Modify UAC Setting", and click "Enable".
- 2) Drag the slider to the bottom, click "OK" and reboot PC.



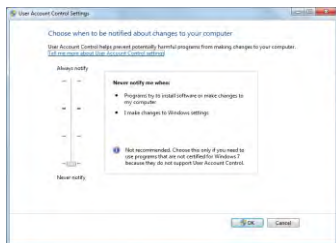
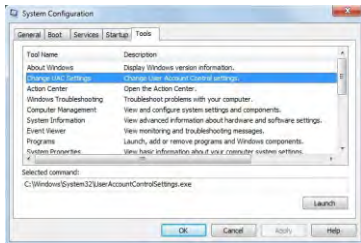

Picture 8

4. After setting, re-enter camera IP in IE and install ActiveX Control to login the web client IPCCtrl. Enter default admin user name and password, both of which are "admin", or operator user name and password, both of which are "guest".



Picture 9

## Step 5 Live View and Lends Adjustment

1 After login, user can view live video directly, as the picture shows.  
**[Note]:** Please refer to the help file of IPCCtrl for detailed explanation.



Picture 10

2 Adjust camera direction, configure camera parameters in IPCCtrl until the live view meets requirement.

[Note]: When adjust camera lens, do not push it too hard, or the camera parts may be damaged.

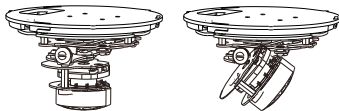

Picture 11

## Step 6 Fix Device

1 After positioning the device, fix the holder onto the ceiling or wall with 3 tapping screws. Hole size can be referred to in the appendix.

2 Top cabling

Align the housing's cable hole (black block piece) to the holder's cable hole, install the housing onto the holder, rotate the housing as the picture shows, and tighten inner hexagon screws to fix the housing and tear off the anti-dust film.

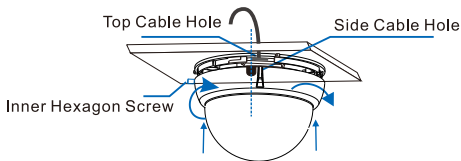

Picture 12

### 3 Slide cabling

Take off the block piece of the housing's cable hole, install the housing onto the holder, route the cable through the cable hole, then rotate the housing anti-clockwise till it is tight (about 1cm), screw up the inner hexagon screw and fix the housing.

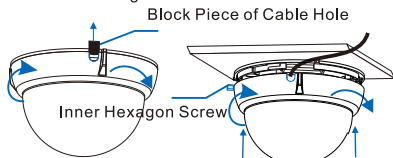

Picture 13

## Bracket Mounting Instruction

If the condition cannot satisfy ceiling mount, user can also mount with ceiling bracket or wall bracket. It is better not apply wall mounting without wall bracket.

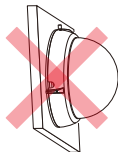

Picture 14

### Step 1 Install Bracket Connect

Install bracket connector on the top of the device with screws.

### Step 2 Fix Bracket and Connector

Tighten and fix bracket connector and the bracket.

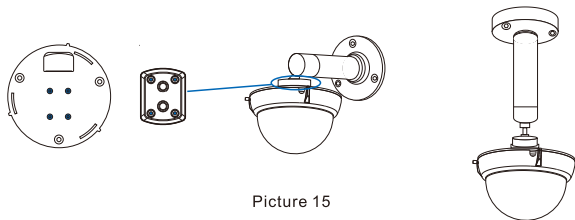

Picture 15

## Appendix: Optional Accessories

These accessories are not included in standard product packet. Please contact the dealer if you need.

- 1 Ceiling mount bracket
- 2 Wall mount bracket
- 3 Bracket connector

## Appendix: Holder Size

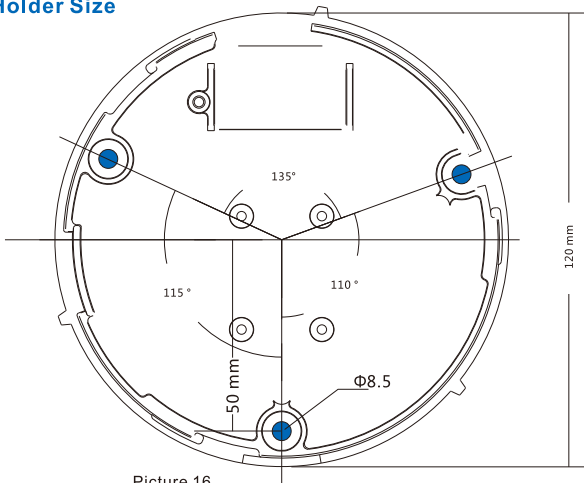

Picture 16

Scale: 1:2

## **Kedacom Two (2) Year Limited Hardware Warranty**

### **WHAT IS COVERED BY THIS WARRANTY?**

Kedacom warrants the Kedacom-branded hardware product and accessories contained in the original packaging (hereinafter referred to as "Kedacom Product") against defects in materials and workmanship when used normally in accordance with Kedacom's published guidelines for a period of TWO (2) YEARS from the date of original retail purchase by the end-user purchaser (hereinafter referred to as "Warranty Period"). Kedacom's published guidelines include but are not limited to information contained in technical specifications, user guides, and service communications. The preceding applies unless otherwise agreed in the contract.

### **WHAT IS NOT COVERED BY THIS WARRANTY?**

This warranty does not apply to any non-Kedacom branded hardware products or any software, even if packaged or sold with Kedacom hardware. Manufacturers, suppliers, or publishers, other than Kedacom, may provide their own warranties to you but Kedacom, in so far as permitted by law, provides their products "AS IS". Software distributed by Kedacom with or without the Kedacom brand (including, but not limited to system software) is not covered by this warranty. Please refer to the licensing agreement accompanying the software for details of your rights with respect to its use. Kedacom does not warrant that the operation of the Kedacom Product will be uninterrupted or error-free. Kedacom is not responsible for damage arising from failures to follow instructions relating to the Kedacom Product's use.

This warranty does not apply: (a) to consumable parts, such as batteries, unless failure has occurred due to a defect in materials or workmanship; (b) to cosmetic damage, including but not limited to scratches, dents, and broken plastic on ports; (c) to damage caused by use with another product; (d) to damage caused by acts outside the control of Kedacom, including without limitation acts of God, accidents, abuse, misuse, fire, storms, earthquakes, flood, or other external cause; (e) to damage caused by exposure of the product to heat, bright light, sun, liquids, sand, or other contaminants; (f) to damage caused by operating the Kedacom Product outside Kedacom's published guidelines; (g) to damage caused by service (including upgrades and expansions) performed by anyone other than a representative of Kedacom, Kedacom employee, or authorized Kedacom agent; (h) to an Kedacom Product that has been modified to alter functionality or capability without the written permission of Kedacom; (i) to defects caused by normal wear and tear or otherwise due to the normal aging of the Kedacom Product, or (j) if any serial number has been removed or defaced from the Kedacom Product.

### **YOUR RESPONSIBILITIES**

If your Kedacom product is capable of storing data and other information, you should make periodic backup copies of the information contained on the storage media to protect the contents and as a precaution against possible operational failures.

Before receiving warranty service, Kedacom or its authorized agents may require that you furnish proof of purchase details, respond to questions designed to assist with diagnosing potential issues, and follow Kedacom's procedures for obtaining warranty service. Before submitting your Kedacom Product for warranty service, you should maintain a separate backup copy of the contents of its storage media, remove all personal information that you want to protect, and disable all security passwords.

During warranty service, it is possible that the contents of the Kedacom product's storage media will be lost, replaced or reformatted. In such an event, Kedacom and its authorized agents are not responsible for any loss of data or other information contained on the storage media or any other part of the Kedacom product serviced.

Following warranty service, your Kedacom Product or a replacement product will be returned to you as your Kedacom Product was configured when originally purchased, subject to applicable updates. You will be responsible for reinstalling all other data and information. Recovery and reinstallation of other data and information are not covered under this warranty.

### **WHAT WILL KEDACOM DO IF THE WARRANTY IS BREACHED?**

If during the Warranty Period, you submit a valid claim to Kedacom or an authorized Kedacom agent, Kedacom will, at its option, (i) repair the Kedacom Product using new or previously used parts that are equivalent to new in performance and reliability, or (ii) exchange the Kedacom Product for a refund of your purchase price.

A Kedacom replacement part or product, including a user-installable Kedacom part that has been installed in accordance with instructions provided by Kedacom, assumes the remaining warranty of the Kedacom Product or ninety (90) days from the date of replacement or repair, whichever provides longer coverage for you. When a product or part is replaced or a refund provided, any replacement item becomes your property and the replaced or refunded item becomes Kedacom's property. Kedacom reserves the right to refund the purchase price as its exclusive warranty remedy.

### **HOW TO OBTAIN WARRANTY SERVICE?**

To seek warranty service, please contact a local authorized Kedacom agent. When contacting the agent via telephone, other charges may apply depending on your location.

### **User Information**

Complete the form below and keep for ready reference.

User Name:	
Address:	Postal Code:
Tel:	Mobile:
Fax:	E-Mail:
Product Name:	Product Model:
Date of Purchase:	



客户咨询热线：**800-828-2866** **400-828-2866**

**KEDACOM**

**苏州科达科技股份有限公司**

Suzhou Keda Technology Co.,Ltd.

中国: 江苏省苏州市高新区金山路131号(215011)

Tel: +86-512-68418188 Fax: +86-512-68412699

Suzhou Keda Technology Co.,Ltd.

Singapore: 627A Aljunied Road, #09-07, BizTech Centre, Singapore 389842

Tel: +65-6842-5700 Fax: +65-6842-5900